

- 1 Digital display actual value
- 2 2nd digital display (if active)
- 3 LED-display relay function
- 4 Key for setpoint and parameter mode
- 5 Setpoint adjustment
- 6 Parameter mode lock switch (back face)



Certifications: DIN, BV, DNV, GL

Brief description:

KFM 92 is a microprocessor based industry controller series in panel mounting- format 96 x 96 mm. Design and operating elements are especially devised for easy and convenient handling and operation. An assembly system renders possible the simple basic version as well as a plurality of variants with up to 8 relays, several digital and analog out- and inputs and other additional devices. All relay contacts are implemented as potential-free changeover contacts. Depending on the version, external RC combinations are included, internal RC combinations for optional connection to terminals (N.O. contact factory- connected) or the N.O. contacts of all relays are permanently wired internally with RC combinations. The scope of delivery includes pluggable terminal blocks.

Types:

(depending on configuration*):

- indicator
- one stage controller
- two stage controller
- heating / cooling controller
- positioner / follow-up controller
- two- point- PID controller
- three- point- PID controller
- three- point- step controller
- continuous controller
- continuous controller, 2 outputs

type:

- 9201.
- 9210.
- 9220.
- 9230.
- 9240.
- 9250.
- 9260.
- 9270.
- 9280.
- 9281.

Inputs:

- max. 4 measuring inputs, acc. to sub-type:
- Pt100 DIN, 0...400°C
- Pt100 DIN, 0...100°C
- thermo couple Ni Cr NI (type K)0...1200°C
- thermo couple Fe Cu NI (type J)0... 900°C
- thermo couple Pt Rh Pt (type S)0...1700°C
- feedback device 0...100 up to 1000 Ω
- standard signal 0(4)...20mA, 0(2)...10V
- combined input Pt100 / standard signal

- type suffix
- none (or 0)
 - 1.
 - n.
 - f.
 - p.
 - w.
 - e.
 - q.

Sub-types:

- basic function
- basic function + 1 additional contact
- basic function + 2 additional contacts
- 2 x basic function
- extension: logic output

suffix (*)

- .0
- .1
- .2
- .3
- ..L

function extensions

- cascade controller
- program controller
- ramp set point value
- step controller

suffix (*)

- 991k
- 991p
- 991r
- 991t

Additional devices:

- additional analog inputs
- external set value incl. switch-over
- second set value incl. switch-over
- binary input to switch special functions
- additional switching contacts
- analog signal outputs
- serial interface RS 232/485
- interface Profibus, Interbus S, other

(*)

- (99) a
- (99) bwa
- (99) bwz
- (99) b..
- (99) f..
- (99) o.
- (99) s.
- (99) sp/si.

Ranges:

Pt 100: 0...400°C, switchable to °F, optional: other ranges; for standard signal range adjustable -999 to 4000. Setpoint ranges can be limited by menu

Displays:

2 four- figured digital displays, decimal point adjustable, upper display: actual value, lower display: other selectable data, up to 8 LEDs for relays function display.

Display of function:

Hold down the P-key for more than 5 sec to get a short-cut message of the configured function on the display (=position 3-5 of list number) (in case of locked parameter mode only).

Measuring line monitoring:

Display "Err 1...4" in case of measuring line fault and adjustable safety shut down of all outputs

Outputs:

up to 8 relays with potential free change over switch, as control outputs or as additional contacts, capacity: 250V 2A, incl. spark extinction (for normally open contacts) 1-2 continuous outputs 0/4...20mA, 0/2...10V as control or signal outputs(apparent ohmic load 500 Ω)

* In case of more than 1 extension there is at the data plate only once '99' , f.e. 92700-99aw-ogx-rü. For more information see corresponding data sheets.

Installation:

Before installation inspect the controller for any visible signs of damage caused during transport. Check power supply acc. to name plate. Push the housing from the front into the DIN- panel cut-out and secure from behind with the fastening devices supplied.

Electrical wiring:

Plug bar on the back face of the controller; connect up the controller at the rear following the wiring diagram; wire cross section max. 1,5 mm²

- To avoid cross interference *all low voltage measuring lines and pilot wires* must be encased in a **shielded cable** (the shielding must be earthed one-sided).
- The control leads must be **fused externally** to protect the output relays.
- Phase wire and neutral wire must not be transposed.

Putting into operation:

Switch on power supply. Digital display and control lamps (if available) will light up according to the setpoint after some seconds. If nothing happens check the fine-wire fuse (if available) on the back panel of the controller and the electrical wiring. Adjust set value and check other adjustments.

Maintenance:

All electronic controllers in the product range of the manufacturer are virtually maintenance-free. Provided that the controller is correctly installed and put into operation and is protected against mechanical damage and inadmissible operating conditions, it should give years of trouble-free service. *In case of faults* repair work by the customer should be restricted to the externally accessible leads and connections and components the customer is expressly permitted to deal with himself (bridge circuits, fuses).

All further work, especially on internal components will terminate warranty, makes subsequent inspection and fault repair more difficult and can cause considerable damage to the circuitry.

For repair remittance remove plug board with connected leads on the rear side, loosen fastening devices and remove controller from the panel.

In case of remittance please give precise details of the fault to reduce time and cost of repair.

Error messages:

- | | |
|-----------|---|
| Err 1...6 | Fault on measuring input nr. ...
check measuring lines for short circuit or breakage
check measuring input by connecting a RTD |
| Err 55 | Fault on loading the parameter;
press any key, the controller starts in emergency operation mode,
configuration of the parameters has to be checked |
| Err 50 | Hardware error in program section |
| Err 52 | Hardware error in data section
no further operation possible, remit controller for repair |
| Err 58 | Binary inputs out of function (status = 0), remit controller for repair |
| Err 59 | Digital outputs out of function (switched off), remit controller for repair |
| Err 60 | Relay outputs out of function (switched off), remit controller for repair |
| Err 61 | Analogue outputs out of function (0 %), remit controller for repair |
| | Error messages during self adaptation: |
| Err 202 | Ambient conditions are not suitable for self adaptation;
adjust parameter manually |
| Err 205 | routine exceeded the setpoint
raise setpoint or lower actual value and start adaptation again |
| Err 206 | Fault on measuring input during adaptation;
check the wiring and start adaptation again |

Operating status:

635

The *upper display* shows the actual value (channel / measuring input 1), the *lower display* remains empty or (depending on the version and settings) shows

- the attendant unit of measure (°C, °F, %...)
- an additional actual value, the setpoint value or the controller output value Y
- or the additional actual value only when the  key is pressed.

Alternative type:



switch over the *upper display* to the several actual values by pressing the  key, the lower display shows the number of the attendant measuring input.

Setpoint value setting:

press  - key *shortly* (do *not* hold down)

SP
635

The *upper display* shows the abbreviation of the activated setpoint adjustment mode, the *lower display* shows the adjusted value.





The indicated value can now be changed by the  (lower) and  (higher) -keys. Each variation of the set value is *immediately* active, without any more operating steps. The arrow keys have a built-in accelerator mode: longer pressing causes faster alterations.

Return to operating level:

Press  - key *shortly* (or automatically after 30 seconds without any key-action)

optional: Press  - key *shortly* again: *SP =set values of further control loops (*=no.) / SP* =further set values of the control loop / SPE =external setpoint (display mode only); *flashing* display signifies that the function is not active at the moment.



Manual operation: (optional)

Hold down  - key and press  - key, then release both keys.
(*optional: switch on and off using separate  - key*)
(for multi-channel controllers first enter the channel number *, and press  - key, then:)

H
635

The *lower display* shows "H *" and - if activated - the output position. The *upper display* still shows the actual value. The automatic control is interrupted.

Manual control is now possible using the ... - keys.

Return to operating level **only** by pressing the  - key (if present: the  - key) .
(no automatic return from the manual mode)

optional: starting the self adaptation (ref. to chapter Optimization):

On manual operation level  - key >5 sec ;
the *lower display* indicates "-Ad-".

Cancel:  - key >5 sec again

Access from operating level.

Unlock the access first:

Turn the switch on the rear panel of the controller to position "U" = unlocked
(Lock access after the adjustments: Switch position to "L" = locked).



After the parameter level (refer to the instructions to each level) has been invoked, the first setting is shown and can be modified.



It is **not** possible to invoke the parameter level when the switch is locked .
In this case the display shows the abbreviation of the configured controller type.

Confirm the entry and / or **move on** to next parameter:
press the **P** -key *briefly*

Settings in detail:

(not available on all types)

Level 1:	Invoke: Hold down the P - key for more than 5 sec. until the display changes	<i>factory setting:</i>	<i>notes:</i>
CH	channel selection (no.) for multi-channel controller (only)		
*P	proportional range Xp (%) (ref. to chapter "Optimization")	25,0	___
*I	integral action time Tn (min) (ref. to chapter "Optimization")	7,0	___
*d	rate time Tv (min) (ref. to chapter "Optimization")	0,2	___
*Sh	sensitivity of response Xsh (%)	0,1	___
SA..	switching interval (absolut value) for following (additional) contact no...	5,0	___
SP..	set point for independent additional contact no...	0,0	___
*Sd..	switching difference for additional contact no...	3,0	___
		(*201,701/SA3:10,0)	

Return to operating status:

*Briefly press the **P** - key (or automatically after 30 sec.)*

Level 2:	Invoke: Hold down P - key and press V - key, hold down both keys for more than 5 sec. until display changes.		
Unit	switch-over the displayunit (°C / °F)	C	___
*bLo/*bHI	start / end of display range for voltage- / current -input (only)	#	___
*ELo/*EHI	start / end of range for external setpoint (only), referring to signal	#	___
*SLo/*SHI	start / end of range for signal output (only), referring to signal	#	___
nSt	modification of decimal point characters (0 / 1 / 2)	0	___
*Lo / *HI	start / end of setpoint range (°C /°F or value)	#	___
dSPL	select display function for lower display (AUS / SP / Y / IST2)	AUS	___
	(AUS = off, SP = setpoint, Y = output, Ist2 = actual value of channel / measuring input 2)		

Return to operating status:

*Briefly press the **P** - key (or automatically after 30 sec.)*

* = channel no. in case of multiple measuring inputs or control loops. # = *acc. to range*

1. manual optimization

An optimum adaptation of the control parameters (P,I,D) is necessary in order to balance an appearing deviation as quickly, non-oscillating and exactly as possible, according to the given operating conditions.

Generally these adjustments require a lot of professional knowledge that cannot be replaced by this brief information.

The following informations are for help purpose only:

P = proportional band Xp (%):

lower value = longer impulses, more sensitive reaction

higher value = shorter impulses, less sensitive reaction

Examples: - Oscillating temperature without distinct initial overshoot: Xp too low;
- The setpoint is reached very slowly after initial exceeding: Xp too high.

I = integral action time Tn (min):

lower value= shorter impulse gaps, faster balancing

higher value= longer impulse gaps, slower balancing

Examples: - the set value is reached very slowly without overshooting: Tn too high;
- high initial overshoot followed by fading oscillation: Tn too low.

D = rate time Tv (min):

increases the controller reaction in case of fast actual value or setpoint alterations (adjust only if necessary). Higher values cause higher increase.

2. Self-adaptation

The self-adaptation is an automatic procedure that determines and self-adjusts the optimum control parameters Xp, Tn and Tv.

Operation, if contained in supply schedule:

(Parameter-safety-switch on the rear panel of the controller (if available) has to be unlocked: position "u")

Check starting assumptions:

Actual value at least 20% below the adjusted set value,(e.g.:heating phase), otherwise first: Lower actual value adequately by manual operation (position of final control element) (quick circuits) or increase setpoint adequately, if admissible. (faster procedure for slower circuits)

Call manual operation level: Press **▼** - key plus **▲** - key (optional: seperate key).

Check controller output: must not be higher than 85% , reduce if necessary.

Start self-adaptation: Hold down **P** - key for more than 5 sec. on manual operation level.

During operation the lower display shows: "-Ad-",
the upper display still shows permanently the actual value.

Information about computer operation: First the self-adaptation program waits for stabilization of the actual value according to the given controller output (actual value alteration < 0,1% / min), then it increases the output signal about 10% or, in case of three- point- step controller operation, it triggers an output impulse with about 10% of the adjusted regulating time.

The optimum parameters are computed according to the unit- step response.

Cancel: Press **P** - key for more than 5 sec. = return to manual operation level

After successfully finishing the procedure the controller will return **automatically** to operating level.

Unsuccessful adaptation (Display shows error code, ref.to chapter error messages):

Press **P** - key again: Return to manual operation level

eliminate the indicated error

start adaptation again: **P** - key > 5 sec.

or return to operating level: **P** - key shortly

Access from the operating level.

Unlock the access first: Turn the switch on the rear panel of the controller to position "U" (= unlocked). *It is **not** possible to configure the controller with **locked** switch.*
(Lock access after the adjustments: Switch position to "L"= locked)

Hold down the **P** - key and press the **▲** - key,
hold down both keys for more than 5 sec. until the display changes

Code
0

Enter the code number (password) **▼...▲** (1...9999), factory setting: 1
move on to next input: *briefly* press **P** - key

Code
1

Alternatively: Hold down key after entering code for more than 10 sec.
Possibility to modify code number (optional)

Conf
702

Select control function (*type dependent*): the displayed ID number for the configured control function can be changed by pressing the **▲** - key.
(Example Type 930K31: choose (92..) 200, 201, 700, 701)

Return to operating level: *briefly* press the **P** - key
or

move on to following **adjustments**: hold down **P** - key for more than 5 sec.

Note: when switching is continued after a function has been changed, the display will first flash for several seconds, only then will the controller return to the selected level.

1st
00

Configurations are displayed in succession (type and design dependent)
and can be changed: **▼...▲**
(move on to next input: press **P** - key *shortly*)

		<i>factory setting</i>
Ist*	correction value to change the controller display (+ / -)	0.0
EinG	type of measuring input Pt 100 / DC-signal: "rtd / lu"	<i>rtd</i>
Ain*	type of DC signal for input No.*:rtd/ 0/4-20mA/ 0/2...10V (observe different terminal connection I/U)	4...20 mA (91...rtd)
Filt	digital input filter for attenuation of disturbed input signals "0...99" (%) (no filter: enter 0)	92 %
SP 2/E	kind of 2nd/ external setpoint: Add/ Sub/ AbS (adding / subtracting / absolute)	AbS
*Y' '	travel time of the actuator "6...600" (sec.)	60 sec.
*cy' '	switching frequency for 2-point controllers: "2...120" (sec.)	20 sec.
*out	adjusting kind of output signal "0...20/ 4...20(mA)/ 0...10/ 2..10(V)"	4...20 mA
*out	adjusting output characteristics direct / inverted "di / in" (for 2 output signals:"in in / in di / di in / di di")	<i>in</i>
*td	for 2 output signals: dead center between output 1 and 2 "0...10%"	0
AP	correction of the output signal operating point	50%
FG A/E	automatical adjustment for teletransmitter input (ref. sheet 99ar)	
Sou*	adjusting kind of information signal "Ist/Soll.." (actual/ setp.value)	<i>Ist1</i>
Sou*	adjusting type of information signal "0..20/4..20(mA)/0..10/2..10(V)" (*Sou= signal 1, Sou2= signal 2)	4...20 mA
*Y_S	behaviour of the output in case of measuring line fault: relay position:"rel1 / rel2 / AUS" (AUS = relays off)	<i>rel2(70.),rel1(20.)</i>
	continuous output position: "0...100" (%)	0
reL..	function selection for add. switching contacts :	
	add. contact 1 (relay-no.*)	<i>SoA(701),StA(201)</i>
	add. contact 2 (relay-no.*)	<i>Su A</i>
	select the corresponding measuring input / control circuit	<i>Ist1</i>
	relay condition in case of measuring line fault: "SiE/SiA"(on/off)	<i>Si A</i>
Adr	bus adress (adress no.) (for interface equipment only)	5

Return to operating level: *briefly* press the **P** - key again

* = In case of multiple measuring inputs or control loops: relay- or channel number

Selectable switching functions (depending on version):
For setting please refer to configuration level under „reL...“

Switching functions for trailing contacts:

- LC A** Break contact on either side of setpoint (Limit comparator). Relay drops out as deviation increases (**Aus = off**)
- LC E** Make contact on either side of setpoint (Limit comparator). Relay picks up as deviation increases (**Ein = on**)
- Su A** Break contact below setpoint. Relay drops out as actual value decreases (**Aus = off**)
- Su E** Make contact below setpoint. Relay picks up as actual value decreases (**Ein = on**)
- So A** Break contact above setpoint. Relay drops out as actual value increases (**Aus = off**)
- So E** Make contact above setpoint. Relay picks up as actual value increases (**Ein = on**)
- St A** Heating stage below setpoint. Relay drops out actual value increases (**Aus = off**)

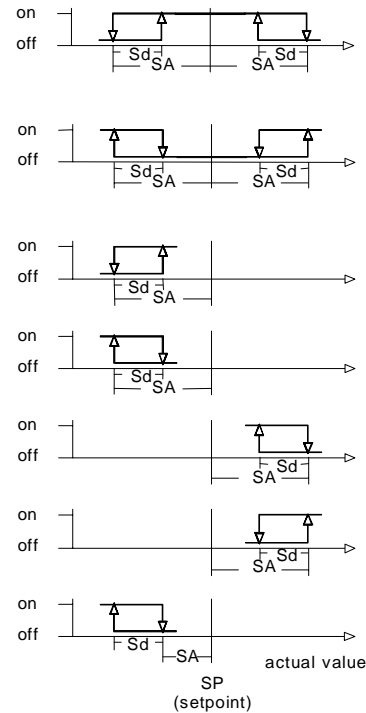

Switching functions for independent contacts:

- US A** Relay drops out with increasing actual value (**Aus = off**)
- US E** Relay picks up with increasing actual value (**Ein = on**)

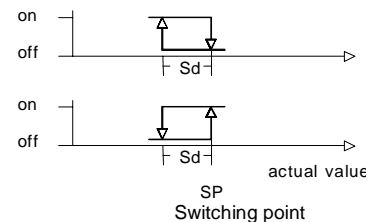

Service function:

Ein/Aus contact is constantly switched on (**Ein**) or off (**Aus**) respectively

Special function:

SF6 as SoA but switching point at setpoint, control output around SA below

In each case additional settings follow under "reL." after the selection is acknowledged (P key) (depending on version):

Ist./ Y assigned value: actual value no. ... or Y (actuating signal)

CH../SP.(only) for trailing contacts: assigned control circuit / channel (no.) or assigned setpoint (1SP., rSP, SP.1, ..)
for independent contacts: assignment of parameter input (channel no.)

"Safety" shut down (in case of measuring line fault):

SI E Relay for "Safety" behaviour in event of measuring circuit error: relay **on**

SI A Relay for "Safety" behaviour in event of measuring circuit error: relay **off**

Characteristics: (parameters dep. on sub type:)

Adjustment on parameter level, with lock switch, pre adjusted on customer's demand.
 Proportional band Xp: 0,1...999,9 %
 Integral action time Tn: 0,0...999,9 min
 Rate time Tv: 0,0...99,9 min
 Sensitivity of response Xsh: 0,1...1,0 %
 Travel time of the actuator Tm: 6...600 sec
 Switching frequency cy: 2...120 sec
 Function characteristics: direct / inverted
 Switching interval SA (add. contacts): 0..100,0 K
 Switching difference Sd: 0,1...100,0 K

Additional contact functions:

As switching interval above and below setpoint or independent adjustable with own setpoint and measuring input, switching function adjustable (ref. to chapter additional switching contacts)

Installation dimensions:

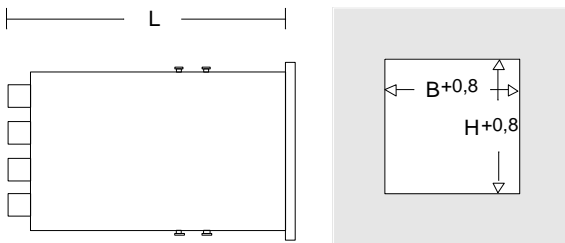

Form 96x96: L=150mm, B=92mm, H=92mm
 Form 72x144: L=170mm, B=68mm, H=139mm

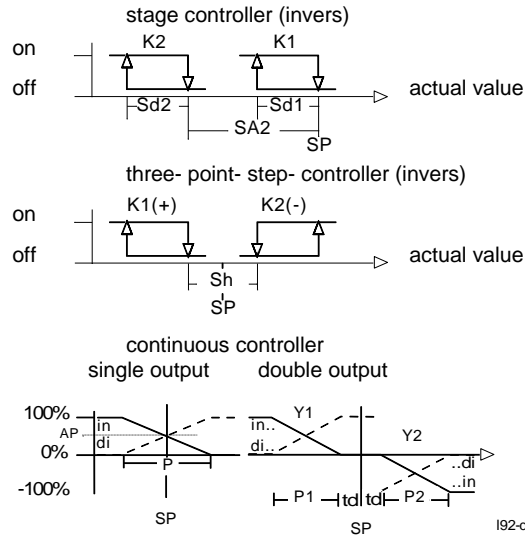

Other data:

Housing for panel mounting, 96 x 96 mm (type 92.., 93..) or 72 x 144 mm (type 94)
 Power supply: 100-250VAC, 24VAC/DC (appr. 14 VA)
 Protective system DIN EN60529: IP54 resp. IP65 (flat seal + 4 mounting elements), terminals IP20
 Permissible ambient temperature: 0...60°C
 Nominal temperature: 20°C
 Climatic category: Relative humidity <= 75 % yearly average, no condensation, KWF to EN 60 529
 EMC: refer to EN 61326

Wiring diagram: valid for each delivered controller is the wiring diagram on its casing only)

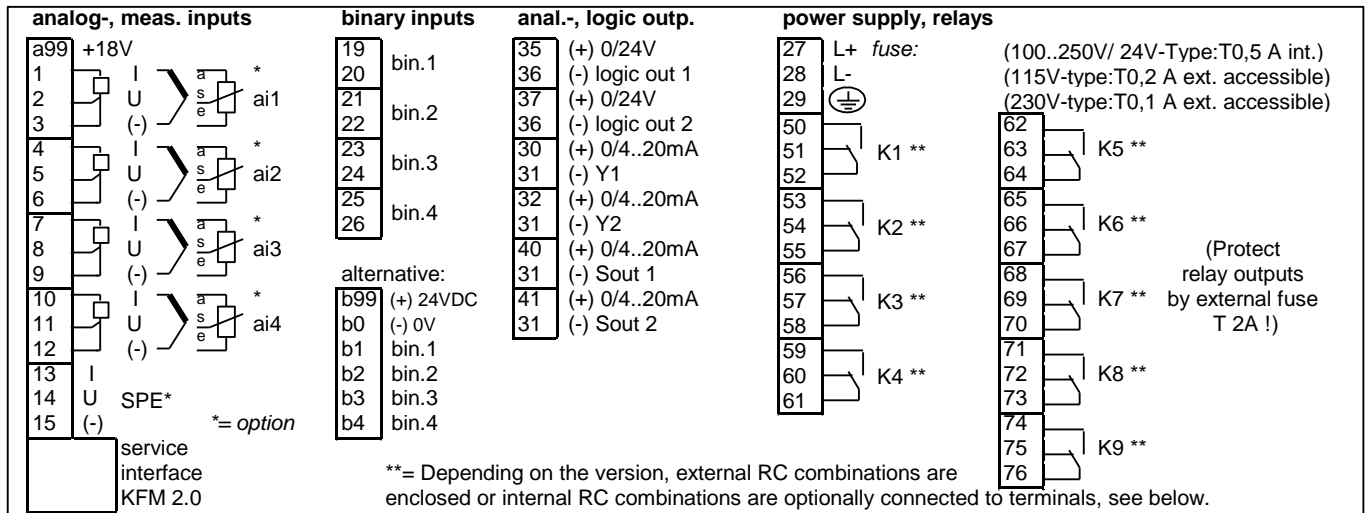

Wiring, examples for input 1 and output 1 respectively:

