

- 1 Display for relay function
- 2 Descriptive text for relay functions
- 3 Descriptive texts and digital value displays
- 4 Unit of display
- 5 Key for setpoint and parameter mode
- 6 Setpoint adjustment

certifications: DIN, GL, BV



General:

KFM 903 is an industrial microcomputer-based controller series in control panel format 96 x 96 mm with a performance range of up to 9 relay outputs (changeover), various signal inputs and outputs as well as numerous possible optional extras. Communication with control systems is also possible. Additional contacts can be switched time dependent using the integrated real time clock.

Controllers of the series 903 can be delivered with the type extension K in a freely programmable version and then available functional packages can be added arbitrary within the hardware, using a graphical workspace, so that a separate control system is often not necessary.

The belonging module software 99pkm provides beside ready to use controller modules a large number of control functions and logical operations compact within the individual device, furthermore expansion modules, an external malfunction alarm unit or a second freely programmable controller 903K can be added to it by using the standard interface.

Alternatively, the delivery can be done unprogrammed with hardware in various types. In this case the programming is provided by the customer or at extra cost by the factory.

The transmissive colour TFT indication is easy to read in both light and dark environments.

Parameter set, TFT- configuration, data logger recordings and fault history can be transferred by means of conventional USB stick. Irrespective from that, the continuous logger data is automatically saved on a regular basis if the USB stick is inserted.

The touch operation of the TFT- display is optionally available.

Depending on version, the industrial controller can configured and read out via USB stick.

Content

Hardware- types (unprogrammed)	3
Intended use.....	4
Personnel qualification	4
Installation	4
Electrical safety	4
Electrical wiring.....	5
Putting into operation.....	5
Maintenance.....	5
Operating status	6
Setpoint value setting	7
Manual operation	7
Parameter level 1	8
Parameter level 2	9
Configuration level	10
Manual optimization.....	12
Self- adaption (optional)	13
Additional contact – type of function	14
Additional contact – special functions	15
Software	16
PKS	16
PKM	16
PKD.....	16
PCS.....	16
Error messages	17
Technical data	18
Wiring diagram	19
About KFM-Regelungstechnik GmbH.....	20

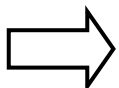

REFERENCE!

This symbol refers to further information in other sections, chapters or other manuals.

Hardware- types (unprogrammed):

Type	Measuring inputs	Binary inputs	Analogue outputs	Relays
903K2223	2	2	2	3
903K2C46	2	12	4	6
903K5828	5	8	2	8
903K5K28	5	20	2	8
903K5K64L	5	20	6	4 (+2 Logik outputs)
903K8223	8	2	2	3

Depending on version, RC elements for external mounting are enclosed, only in exceptional cases internal RC elements are wired on terminals for the selective connection.

versions 903K.. (type suffix)

Measuring inputs * for potentiometer: _ *w,

Analogue outputs * voltage: _ *u

* = Number in case of several in- and outputs

Special versions depending on quantities possible.

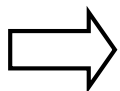

Hardware- expansion modules: see sheet 852..

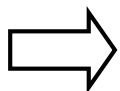

External malfunction alarm display: see sheet 826..

Intended use

The device is intended, in accordance to the technical data, for measuring- and control functions in industrial environments.

Any other use or usage beyond this scope is not considered as intended.

The device is constructed in accordance to the current standards and directives and complies with safety regulations.

Nevertheless, improper use can result in danger to life or property damages.

In order to avoid risks, the device must be used for the intended use in a proper safety condition and in compliance with the delivered technical documentation. Application- related dangers can occur also if the device is appropriate or intended used caused for example by missing safety devices or wrong adjustments.

Personnel qualification

This document includes all information necessary for the intended use of the device described therein.

It has been written exclusively for technically qualified personnel who have been specially trained with expertise in automation technology. Understanding these informations and the technically correct implementation of the delivered documentation are required for safe installation, commissioning as well as for safety during operation. Work on the device and the electrical wiring must only be carried out to the extent described by qualified personell.

Installation

Before installation: Inspect the controller for any visible signs of damage caused during transport. Check power supply according to name plate.

Push the housing from the front into the DIN- panel cut-out and secure from behind with the fastening devices supplied.

Electrical safety

- All electrical lines of the device must be disconnected during installation/dismantling, service- and repair work.
- Load circuits must be fused for the maximum load (see technical data).
- The device is not suitable for installation in areas with an explosion hazard.
- In addition to a faulty installation, also incorrectly (for example by self- adaption) or wrong set parameter values on the device could affect the correct process.
- Safety devices independently from the device should be provided always. The corresponding safety regulations must be observed.
- The operator must be electrostatic discharged (for example by touching a grounded metal object) before plugging or pulling of the connecting cables.
- During commissioning, the delivery defaults of the device can be different from the designated application. The plant constructor is generally responsible for commissioning.

Electrical wiring

- Plug bar on the back face of the controller; connect up the controller following the wiring diagram on the device.
- Only the terminal blocks supplied are to be used. Replace existing old terminal blocks.
- For connecting power supply phase wire and neutral wire must not be transposed.
- Wire cross section max. 1,5 mm²
- Lay input-, output and supply cabling physically separated and not parallel to one another.
- Use shielded and twisted cables for the measuring-, control- and interface circuits to avoid interferences; Ground the shield properly. Do not lay close to components or cables through which current is flowing.
- Do not loop through ground wires, but connect to a common grounding point in the control cabinet; furthermore, a professional potential equalization must be noted and the lines must be kept as short as possible.
- The DIN VDE 0100 "construction of low-voltage systems" respectively the appropriate country specific regulations (for example on basis of IEC 60364) must be followed for the wiring material, the installation and the electrical wiring.
- Depending on version and application, possibly mount the enclosed RC-elements (external) or the jumper (internal RC-elements) in accordance to the wiring diagram.

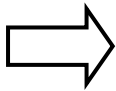

See chapter RC-elements on page 19

Putting into operation

Switch on power supply. Digital display and control lamps (if available) will light up according to the setpoint after some seconds. Adjust set value and check other adjustments.

Maintenance

All electronic controllers in the product range of the manufacturer are virtually maintenance-free. Provided that the controller is correctly installed and put into operation and is protected against mechanical damage and inadmissible operating conditions, it should give years of trouble-free service. In case of faults repair work by the customer should be restricted to the externally accessible leads, connections and components the customer is expressly permitted to deal with himself (bridge circuits, fuses).

All further work, especially on internal components will terminate warranty, makes subsequent inspection and fault repair more difficult and can cause considerable damage to the circuitry.

For repair remittance remove plug board with connected leads on the rear side, loosen fastening devices and remove controller from the panel.

In case of remittance please give precise details of the fault to reduce time and cost of repair.

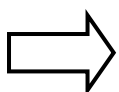

see chapter error messages on page 17

Operating status:

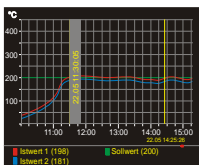
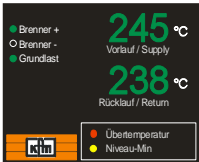
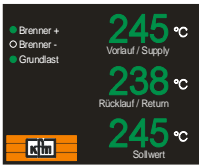

Analog values: Depending on the configuration, up to three values in 10 mm size or two values in 10 mm and two values in 3 mm size can be displayed. A dedicated unit for each value can be configured if desired. The corresponding descriptive texts are changeable by means of the PKS PC software. Depending on equipment, the status of the relays is shown at the left side of the display via a coloured circle icon.

In conjunction with the option of binary input messages, the corresponding texts are shown in the two lower 3 mm display lines if the binary inputs are activated. The corresponding value displays are hidden during this time.

Message list[#]: Briefly press the **▲** - button (*do not hold*)

The display now shows a list of message texts for all activated binary inputs in the order of their occurrence with date and time. Operating messages are displayed by a circle icon coloured green. Pre- alarm messages are displayed by a circle icon coloured yellow. Messages which are configured to the collective relay are marked with a circle icon coloured red. This flashes until the message has been confirmed by means of binary input 1 (reset).

History[#]: Briefly press the **▲** - button (*do not hold*)

As message list, but the display shows a list of optionally saved messages (max. 40, oldest one will be overwritten). Furthermore, gone pre- alarms and malfunction messages are marked with a yellow respectively with a red check mark.

Graphical representation[#]: - Briefly press the **▲** - button (*do not hold*)

Actual- and setpoint values of the controller are displayed as a continuous diagram. The actual recording cycle is signalled by an ongoing red dot. Vertical yellow lines with grey background for date and time represent recording interruptions.

optional: To switch on the cursor press **P** -button *briefly*.

The cursor is moved along the time axis with the **▼** (earlier) / **▲** (later)- buttons, the values of the cursor position are shown in accordance to the date and time.

- *briefly* press the **P** - button to switch off the cursor

Custom specific representations[#]: briefly press the **▲** - button each (*do not hold*)

[#] if existing

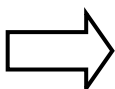

Note: The configuration of the graphical- and custom specific display is possible with the pc- software PKS only, see manual 99pks respectively chapter software on page 16.

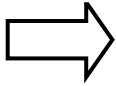

Note: The parameters are shown partially, for full listing see sheet 99pkm_m (module overview).

Setpoint value setting: - Briefly press the **P** - button (do not hold)

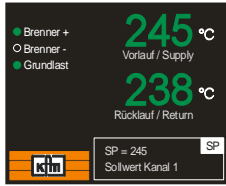

A flashing frame with the description SP shows the activated setpoint level and the parameter name "SP=", the adjusted value as well as an description text optionally.

The displayed value can now be changed using the **▼** (lower) and **▲** (higher) buttons.

A setpoint change is effective *immediately*.

'Arrow' button *acceleration effect*: longer pressing causes faster changing.

return to operating mode:

briefly press the **P** - button (or automatic after > 30 sec)

optional:

*SPB

*SP

SP2 / 3 / ..

SPE

SP-F

Briefly press the **P** - button again each time:

Bus setpoint, forced by an external bus adapter (e.g. 99spde..)

setpoints of additional control loops (*=no)

additional setpoints for the control loop

external setpoint (display only);

flashing description signifies: value is presently *not* active.

Switch over menu SP / SPE

(only in case of adjustment SPEF=MENU (Conf-level))

Manual operation :
(if existing) :

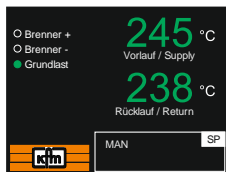

Press and hold the **▼** -button, then additionally press the **▲** - button, then release both.

The upper text display shows "Man." and, if available, the manipulated variable. The control function is switched off.

With the **▼**...**▲** buttons, manual control is now possible.

return to operating mode: **only** with entering **P** - button *briefly*

Alternatively, manual function- overview menu for multi-channel devices:

A summary of the existing controller channels and their manual state is displayed.

Channel	State	Output	Act. val
1	Manual	0%	150
2	Automatic	OFF	0
3	Automatic	OFF	0

return all manual all automatic

The requested channel is marked blue using the **▼**...**▲** buttons, press the **P** - button *briefly* to continue.

Then, select the status "manual" or "automatic" with the **▼**...**▲** buttons, press the **P** - button *briefly* to continue.

The status "manual" provides now a manual control using the **▼**...**▲** buttons, the control function is deactivated.

The control function is activated in the status "automatic".

Press the **P** - button *briefly* to select a channel again.

Note: Marking "all manual" respectively "all automatic" and pressing the **P** - button *briefly* choose for all channels in common.

The corrective signal and the actual value are displayed for each channel.

return to operating mode: **only** with marking "return" and entering **P** - button *briefly*, no automatic switching back!

Note: The deactivated control function is signalled on the operation display by the display "Manual operation" on yellow background.

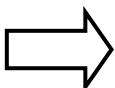
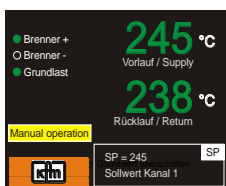

optional: Self- optimisation (see on page 11):

Marked channel **P** -button >5 sec: the display switches to "-Ad-

Parameter level 1

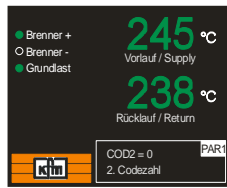

Access from the operating level

After *polling* (see instructions for level PAR 1 / 2), a flashing frame with the description PAR1 / PAR2 shows the activated parameter level.

The *upper text display* shows the first parameter name and the adjusted value, the *lower text display* optionally shows a description text.

continue to the next parameter and/or *confirm* entry:
briefly press each time the **P** - button

To *change* the setting displayed: Press the **▲**...**▼** buttons

Settings in detail: (existence depends on version and type):

PAR1

Polling: press and hold the **P** - button >5 sec, release it after the display reacts.

Factory setting:

COD2

Code number 2 (password) for parameter levels (1...9999)

1

USB Stick

Menu (only) with equipment USB-host and inserted USB stick:
Functions for data transmission

*The requested function is marked blue with the **▲**...**▼** buttons, briefly press the **P** -button to confirm*

"Load parameter only", **"Load TFT-project"**,

"Load complete configuration"

*Parameter set, TFT-project or the complete configuration will be transferred from the USB stick into the device, mark the desired file and confirm with the **P** -button.*

"Save parameter only", **"Save TFT-project"**, **"Save complete configuration"**

Parameter set, TFT-project or the complete configuration will be transferred from the device into the USB stick.

"Cancel" To exit the menu

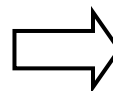

See sheet 903susb for additional information

CH..

(only) for multi-channel controllers: Selection of desired channel (no.)

P

Proportional range Xp (%) (for more details, see "Optimisation")

25,0

I

Integral action time Tn (min) (for more details, see "Optimisation")

7,0

D

Rate time Tv (min) (for more details, see "Optimisation")

0,2

SH

Response sensitivity ("dead zone") Xsh (%)

0,1

SA. (ZA.)**

Setpoint distance (absolute) for following switching contact no.

5,0*

SP.

Independent setpoint for switching contact no.

0,0

SD. (ZD.)**

Hysteresis (switching difference on/off) for switching contact no.

3,0

Only with configuration time dependent additional contacts:

tSt.

Start time for switching contact no., (weekday, hour, minute)

daily/0/0

tL.

Switching time for switching contact no., (days, hours, minutes)

0/0/0

(*..201,701/SA3 :10,0)

**= Je nach Ausführung

return to operating mode:

briefly press the **P** - button (or automatic after > 30 sec)

Parameter level 2

PAR2	Polling: <i>press and hold the</i> P - button, <i>additionally press the</i> V - button, <i>hold both buttons for >5 sec, release them after the display reacts.</i>	
		<i>Factory setting:</i>
COD2	Code number 2 (password) for parameter levels (1...9999)	1
Time adj.	<i>Submenu</i> time adjustment, Polling: <i>press and hold the</i> P - button <i>>5 sec.</i>	
Date	Weekday, calendar day, month, year (actual selection marked white)	-
Time	Hour, minute, second (actual selection marked white)	-
Unit	Switch over of the display unit (cSt / mPas)	cSt
1BLO/1BHI	input 1 (viscosity): start / end of display range	0 / 50
2BLO/2BHI	input 2 (temperature): start / end of display range	0 / 400
1SLO/1SHI	(only) for information signal output: start / end of range	0 / 50
1/2NST	Number of decimal places of the display (0 / 1 / 2, depending on range)	1/0/0
1Lo / 1HI	Setpoint setting range 1 (viscosity), lower / upper limit	0/50
2Lo / 2HI	Setpoint setting range 2 (temperature), lower / upper limit	0/200
FA	weighting factor pulses per liter (0,001 .. 99,999)	1,000
BRGH	Brightness Display (30 ... 100)	50
DSP1/2/3/4	Variable shown in display line 1-4 (10mm) (OFF/SP/Y/IST*/text**/time**) Note: display line 1 to 3: 10mm, if DSP4 = "OFF" otherwise display line 1 and 2: 10mm, display line 3 and 4: 3mm (SP = setpoint, Y=setting var., Ist*=actual value channel*/meas. input*)	1=IST1 2=IST2 3=Y 4=AUS
EIN1/2/3/4	Unit of measurement for display line 1-4 (°C/ °F/ %/ bar/ mbar/ mPas/ cSt/ Kgm3/ mm/ Kpa/ L/ m3/h/ " ") Note: no conversion!	cSt/°C/%
TEXT1/2/3/4	Description text for corresponding display line1..4: choose from a predefined list: (ACT.VAL...,SETPOINT, SUPPLY,RETURN), resp. 1 additionally editable text.,*changeable by PKS-software	1= VISCO 2= TEMP 3=OUTPUT 4=OFF
DSPT	Configuration message text Txt (internal messages in lines 3 and 4, value indication is deactivated), Txl (internal messages list only), Txi (external messages in lines 3 and 4, value indication is deactivated), Txil (external messages list only), OFF	OFF
Hist.	<i>Submenu</i> delete history, Polling: <i>press and hold the</i> P - button <i>>5 sec.</i>	
Del	Delete history (NO / YES)	NO

return to operating mode: briefly press the **P** - button
(or automatic after > 30 sec)

*= ID number in case of several meas. inputs/ control loops. # = *corresp. range*
 **= display line 4 only

Configuration level

Access from the operating level

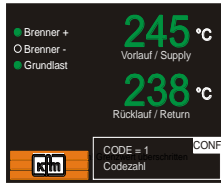

Polling: press and hold the **P** - button, additionally press the **▲** - button, hold both buttons for >5 sec, release them after the display reacts.

A flashing frame with the description CONF shows the activated parameter level. The *upper text display* shows the first parameter name and the adjusted value, the *lower text display* optionally shows a description text.

continue to the next parameter and/or *confirm* entry:
briefly press each time the **P** - button

To *change* the setting displayed:

Number values: Press the **▼**...**▲** buttons, text values:press the **▲** - button



Settings in detail (existence depends on version and type):

		<i>Factory setting</i>
CODE	Code number for configuration level (1...9999), Alternatively: Hold the P button for more than 10 sec after code entry:	1
COD1	Possibility of setting the code number for the configuration level(option).	1
COD2	Possibility of setting the code number for the parameter levels(option).	1
LNG	Language selection of the menu texts (Deutsch,English,User def, Off)	<i>Deutsch</i>
CONF	Selection of the configured controller function (<i>if existent</i>)	

Note: when continuing after changing a function, the display first flashes for a few seconds, only then does the desired switching over or back take place

return to operating mode: Briefly press the **P** - button

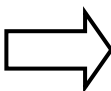
or: **continue** to the following settings:
press the **P** -button and *hold it > 5 sec*

		<i>Factory setting</i>
SPEF	Configuration external setpoint: "BIN" (activation by binary input) / "MENU" (activation from the setpoint level) / "AUS"=OFF	<i>AUS</i>
SP2F	Configuration second setpoint: "BIN" (activation by binary input) / "MENU" (activation from the setpoint level) / "AUS"=OFF	<i>AUS</i>
SPBF	Configuration bus setpoint: "BIN" (activation by a binary input) / "MENU" (activation in the setpoint level) / "BUS" (activation by a status bit via bus-interface adapter, such as 99spde)	<i>BUS</i>
SPOV	Take over external-/ bus setpoint value: "OVER" (the last valid external-/ bus setpoint value is taken over to the internal setpoint value) / "AUS"=OFF (setpoint value unaffected)	<i>AUS</i>
AIN*	Input type for input no.*: "RTD / 0-20 / 4-20(mA) / 0-10 / 2-10(V) / AUS=OFF" (note different terminals for I/U!)**	<i>RTD</i>
AiSP	Input type for input external setpoint: "0-20 / 4-20(mA) / 0-10 / 2-10(V)" (note different terminals for I/U!)	<i>4-20</i>
IST*	Correction value for changing the controller display (+/-)	<i>0.0</i>
SP 2/E	Type of effect of second / external setpoint: "Add/ Sub/ AbS" (adding / subtracting / absolute value)	<i>AbS</i>
*YM	Setting time of the controlled drive "6...600" (sec)	<i>60 sec.</i>
*CY'	Switching frequency in two-point controllers: "2...120" (sec.)	<i>20 sec.</i>
*OUT	Setting output signal "0...20 / 4...20" (mA) / 0...10 / 2...10 (V)"	<i>4...20 mA</i>
*OUT	Setting output characteristic: direct / inverse "di / in" (with 2 outputs: "in in / in di / di in / di di")	<i>in inin</i>
*td	For 2 outputs: dead zone between outputs 1 and 2 "0...10%"	<i>0</i>
*AP	Output signal working point (-100...+100)	<i>50</i>
FG A/E	 Automatic adaption for position feedback input (see sheet 99ar)	
Sou*	Assignment of inform. output signal(s)* (act. value/setp., setting var.)	<i>Ist1</i>
Sou*	Type of information output signal(s)* "0..20/4..20(mA)/0..10/2..10(V)" (* Sout= signal 1; Sou2 = signal 2)	<i>4...20 mA</i>
*Y_S	Behaviour of the setting output in the event of measurement line error: Relay position: "rel1 / rel2 / OFF" Continuous output: "0...100" (%)	<i>rel2(70.),rel1(20.) 0</i>
bin. Eing	Sub-menu for binary input configurations Polling: press the  -button and <i>hold it > 5 sec</i> :	
[#] Di* Dir	Characteristic binary input * direct / inverse / disable (di/in/dis)	<i>di</i>
[#] Di* Func	Function binary input * (Alrm (alarm) / AloR (alarm without reset) / AloS (alarm without collective message) / PrAl (pre alarm)/ PAoR (pre alarm without reset) / PAoS (pre alarm without collective message) / STAT (without))	<i>Alrm</i>
[#] Di* Tdel	Switch-on delay binary input * (0...300 sec)	<i>0</i>
[#] Di* Hist	Save in history binary input * (on/off) #= Number of the module	<i>on</i>
REL*	Function mode of additional contact (relay no.)	<i>SoA(701),StA(201)</i>
REL*	Measuring input / control loop assigned to additional contact	<i>Ist 1</i>
REL*	Add. contact – relay pos. in event of meas. line error "SiE/SiA"(on/off)	<i>Si A</i>
Adr	if equipped with interface: bus address (number)	<i>5</i>
BAUD	if equipped with interface: baudrate (9600/19200/38400)	<i>38400</i>

return to operating mode: briefly press the  - button *again*

* = ID number in case of several inputs / outputs or control loops.

**= Rtd input of ain2 is usable only if equipped with ext. setpoint and activation using SPEF.

manual optimization

An optimum adaptation of the control parameters (P,I,D) is necessary in order to balance an appearing deviation as quickly, non-oscillating and exactly as possible, according to the given operating conditions.

Generally these adjustments require a lot of professional knowledge that cannot be replaced by this brief information. The following informations are for help purpose only:

P = proportional band Xp (%):

lower value = longer impulses (three-point step control), more sensitive reaction,
higher value = shorter impulses (three-point step control), less sensitive reaction.

Examples:

- Oscillating temperature without distinct initial overshoot:

P (Xp) too low;

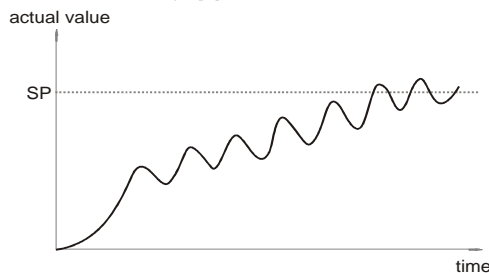

Optimal

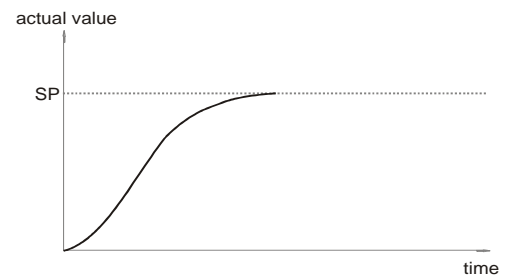

- The setpoint is reached very slowly after initial overshooting:

P (Xp) too high.

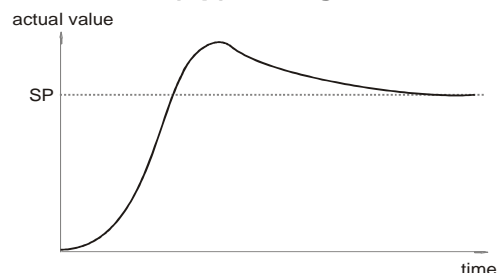

I = integral action time Tn (min):

lower value = shorter impulse gaps (three-point step control), faster balancing,
higher value = longer impulse gaps (three-point step control), slower balancing.

Examples:

- the set value is reached very slowly without overshooting:

I (Tn) too high;

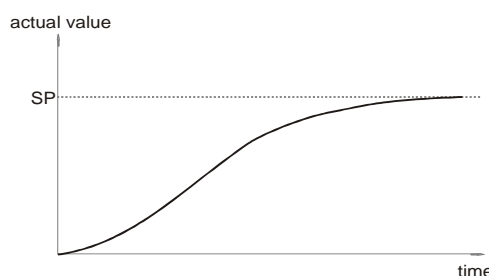

- high initial overshoot followed by fading oscillation:

I (Tn) too low.

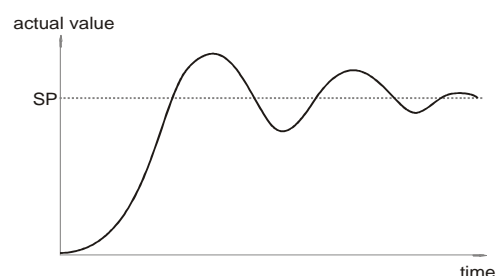

D = rate time Tv (min):

increases the controller reaction in case of fast actual value or setpoint alterations (adjust only if necessary). Higher values cause higher increase.

Self-adaptation (optional)



The self-adaptation is an automatic procedure that determines and self-adjusts the optimum control parameters X_p , T_n and T_v .

Operation, if contained in supply schedule:

(Parameter-safety-switch on the rear panel of the controller (if available) has to be unlocked: position "u")

Check starting assumptions:

Actual value at least 20% below the adjusted set value, (e.g.: heating phase), otherwise first: Lower actual value adequately by manual operation (position of final control element) (quick circuits) or increase setpoint adequately, if admissible. (faster procedure for slower circuits)

Call manual operation level: Press  - key plus  - key (optional: separate key).

Check controller output: must not be higher than 85% , reduce if necessary.

Start self-adaptation: Hold down  - key for more than 5 sec. on manual operation level.

During operation the lower display shows: "-Ad-",
the upper display still shows permanently the actual value.

Information about operation: First the self-adaptation program waits for stabilization of the actual value according to the given controller output (actual value alteration $< 0,1\%$ / min), then it increases the output signal about 10% or, in case of three- point- step controller operation, it triggers an output impulse with about 10% of the adjusted regulating time. The optimum parameters are computed according to the unit- step response.

Cancel: Press  - key for more than 5 sec. = return to manual operation level

After successfully finishing the procedure the controller will return **automatically** to operating level.

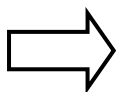

Unsuccessful adaptation

(Display shows error code, ref. to chapter error messages on page 17)

Press  - key again: Return to manual operation level
eliminate the indicated error

start adaptation again:  - key > 5 sec.

or return to operating level:  - key shortly

Selectable switching functions (depending on version):
For setting please refer to configuration level under „reL...“

Switching functions for trailing contacts:

- LC A** Break contact on either side of setpoint (Limit comparator). Relay drops out as deviation increases (**Aus = off**)
- LC E** Make contact on either side of setpoint (Limit comparator). Relay picks up as deviation increases (**Ein = on**)
- Su A** Break contact below setpoint. Relay drops out as actual value decreases (**Aus = off**)
- Su E** Make contact below setpoint. Relay picks up as actual value decreases (**Ein = on**)
- So A** Break contact above setpoint. Relay drops out as actual value increases (**Aus = off**)
- So E** Make contact above setpoint. Relay picks up as actual value increases (**Ein = on**)
- St A** Heating stage below setpoint. Relay drops out as actual value increases
- STCA** Stage above setpoint. Relay drops out as actual value decreases (**Aus = off**)

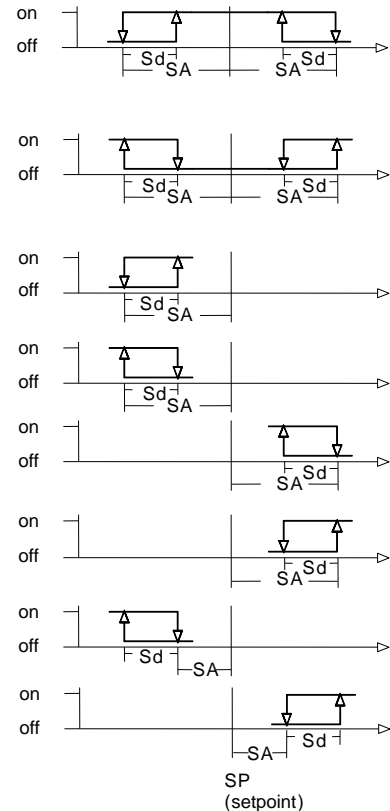

Switching functions for independent contacts:
Hysteresis below:

- US A** Relay drops out with increasing actual value (**Aus = off**)
- US E** Relay picks up with increasing actual value (**Ein = on**)

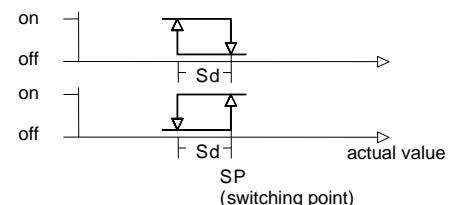

Hysteresis above:

- USCA** Relay picks up as actual value decreases
- USCE** Relay drops out with decreasing actual value

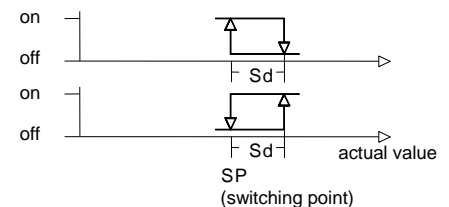

In each case additional settings follow under "reL." after the selection is acknowledged (**P** - key):

- Ist./ Y** assigned value: actual value no. ... or Y (actuating signal)
- CH./SP.** (only) for trailing contacts: assigned control circuit / channel (no.) or assigned setpoint (1SP., rSP, SP.1, ..)
for independent contacts: assignment of parameter input (channel no.)
- SI E** Relay for "Safety" behaviour in event of measuring circuit error: relay **on**
- SI A** Relay for "Safety" behaviour in event of measuring circuit error: relay **off**

Additional contact – special functions (depending on version)

Service function:

Ein/Aus contact is constantly switched on (**Ein**) or off (**Aus**) respectively

Special function:

SF6 as SoA but switching point at setpoint, control output around SA below

Interface function:

BUS Bus function, relay is switched on/off depending on control via service- interface, for example using the profibus- adapter 99spde..

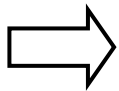

See manual 99sp.. for each adapter

Malfunction message function (when using the internal malfunction alarm display):

SR A /E Collective message function, relay is de-energised / energised if there is an alarm message.

NW A /E New value message, relay is de-energised / energised if a new alarm message appears that has not yet been confirmed with reset.

IP A /E New value pulse, relay is de-energised / energised for 3 sec if a new alarm message appears.

SRIA /E Collective message function with new value pulse, relay is de-energised / energised if there is an alarm message. If a further (new) alarm message appears, the relay is energised for 3 sec.

Switching functions for time dependent contacts:

RTCA time dependent switch-off contact (**Aus=off**)

RTCE time dependent switch-on contact (**Ein=on**)

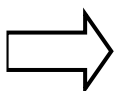

See sheet 99rtc, among other things, examples for daily or weekly switching

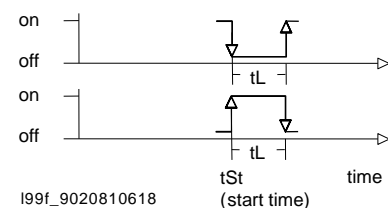

Message measuring line error:

ErrA /E Relay is permanently switched off (**Aus=off**) or on (**Ein=on**) if a measuring line error is present

Software

PKS

- Data transfer, editing and archiving of parameter sets
- Online remote operation
- Graphical display (line recorder)
- Data recording (logger)

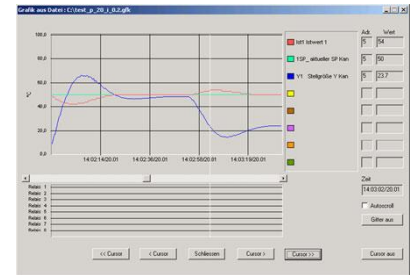
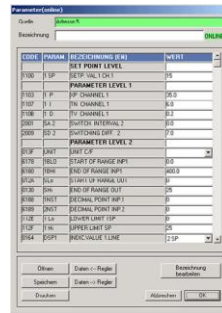

➔ See sheet 99pks

PKM (component of PKS)

- Module software for graphical programming
- Regulation and control

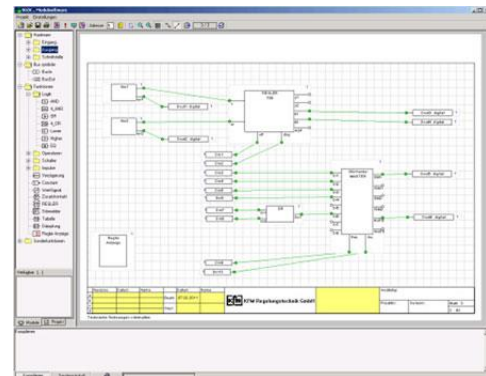

➔ See sheet 99pkm
See sheet 99pkm_m (module overview)

PKD (component of PKS)

- Configuration of the controller display
- Data logger, binary message lists and custom specific logos

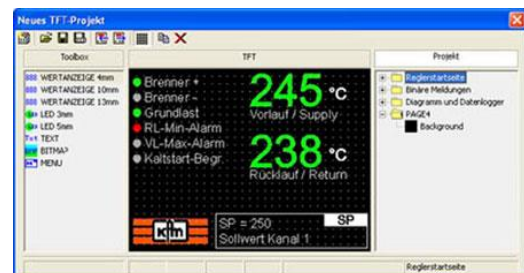

➔ See sheet 99pkd

PCS

- Visualization of custom specific system- and process schemes
- Remote maintenance

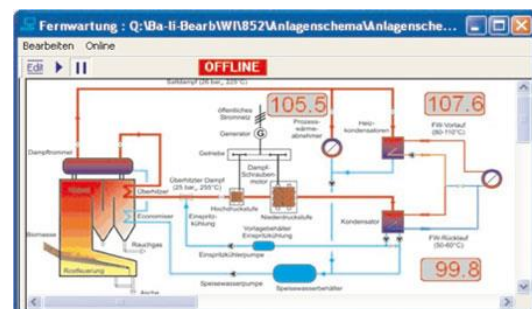

➔ See sheet 99pcs

Error messages

Err 1...6	Fault on measuring input nr. ... check measuring lines for short circuit or breakage check measuring input by connecting a RTD
Err 55	Fault on loading the parameter; press any key, the controller starts in emergency operation mode, configuration of the parameters has to be checked
Err 50	Hardware error in program section
Err 52	Hardware error in data section no further operation possible, remit controller for repair
Err 58	Binary inputs out of function (status = 0), remit controller for repair
Err 59	Digital outputs out of function (switched off), remit controller for repair
Err 60	Relay outputs out of function (switched off), remit controller for repair
Err 61	Analogue outputs out of function (0 %), remit controller for repair
Err 63	Data connection to the hardware expansion modules interrupted, check cables

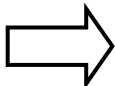

Error messages during self adaptation (see chapter self- adaption on page 13):

Err 202	Ambient conditions are not suitable for self adaptation;  adjust parameters manually (see chapter manual optimization on page 12)
Err 205	routine exceeded the setpoint raise setpoint or lower actual value and start adaptation again
Err 206	Fault on measuring input during adaptation; check the wiring and start adaptation again

Technical data

(depending on type and version)

Characteristics

Parameter-level, code locked.
pre adjusted on customer's demand.

- Proportional band Xp: 0,1...999,9 %
- Integral action time Tn: 0,0...999,9 min
- Rate time Tv: 0,0...99,9 min
- Sensitivity of response Xsh: 0,1...1,0 %
- Travel time of the actuator Tm: 6...600 sec
- Switching frequency cy: 2...120 sec
- Function characteristics: direct / inverted
- Switching interval SA(add. contacts):0..100,0 K
- Switching difference Sd: 0,1...100,0 K

Additional contact functions:

As switching interval above and below setpoint or independent adjustable with own setpoint and measuring input or time dependent(daily-/weekly switch. function), switching function adjustable

Measuring inputs:

- Pt100/standard signal, -200..+800°C/adjust.
- Thermal element * NiCr-Ni (K) 0..1200°C
- Fe-CuNi (J) 0..900°C, PtRh-Pt (S) 0..1700°C
- Remote resistance transmitter * 0...100/1000Ω
- * = option

Ranges:

Pt 100: -200..+800°C, switchable to °F,
standard signal: Display adjustable -999 to 9999, setpoint range can be limited via menu

Binary inputs:

Alternative for potential-free contacts or for external voltage 0 / 24V

Outputs:

- Relay with potential-free changeover contacts, switching power: 250V 2A incl. spark extinction (on the N.O. contact)
- Continuous outputs 0/4...20mA, 0/2...10V (load <= 500 Ω),
- Logic outputs 0/24V max. 40 mA, alternatively outputs with open-collector, max 24 V/100 mA

three- point step controller (inverted)

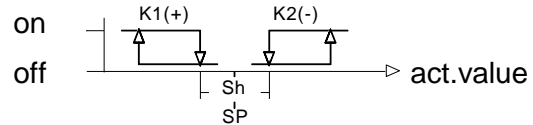

stage controller (inverted)

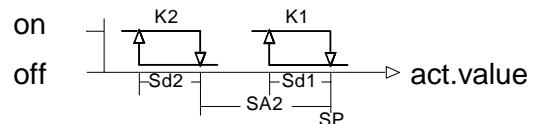

continuous controller
single output double output

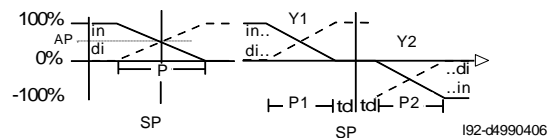

Installation dimensions:

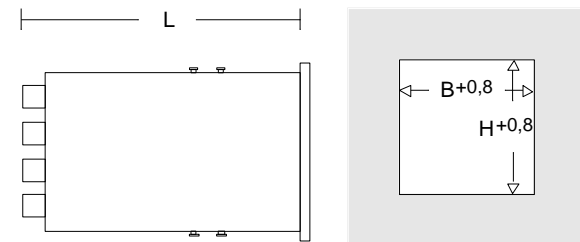

Form 96x96: L=150mm, B=92mm, H=92mm

Other data:

- Housing for panel mounting, 96 x 96 mm
- Power supply: 100..250 VAC, about 14 VA
- alternative 24 V AC / DC
- Protective system EN 60529: IP54 (terminals IP20)
- Permissible ambient temperature: 0...60°C
- Nominal temperature: 20°C
- Climatic category: KWF to EN 60529
- Relative humidity <= 75 % yearly average, no condensation
- EMC: referring to EN 61326

Interfaces:

- Service interface KFM 2.0 RJ45 (socket)
- USB- 2.0 Host plug type A (socket) für USB-memory stick, max. 100 mA

see sheet 99s for additionally information

Wiring diagram:

Example, valid for each delivered controller is the wiring diagram on its casing only

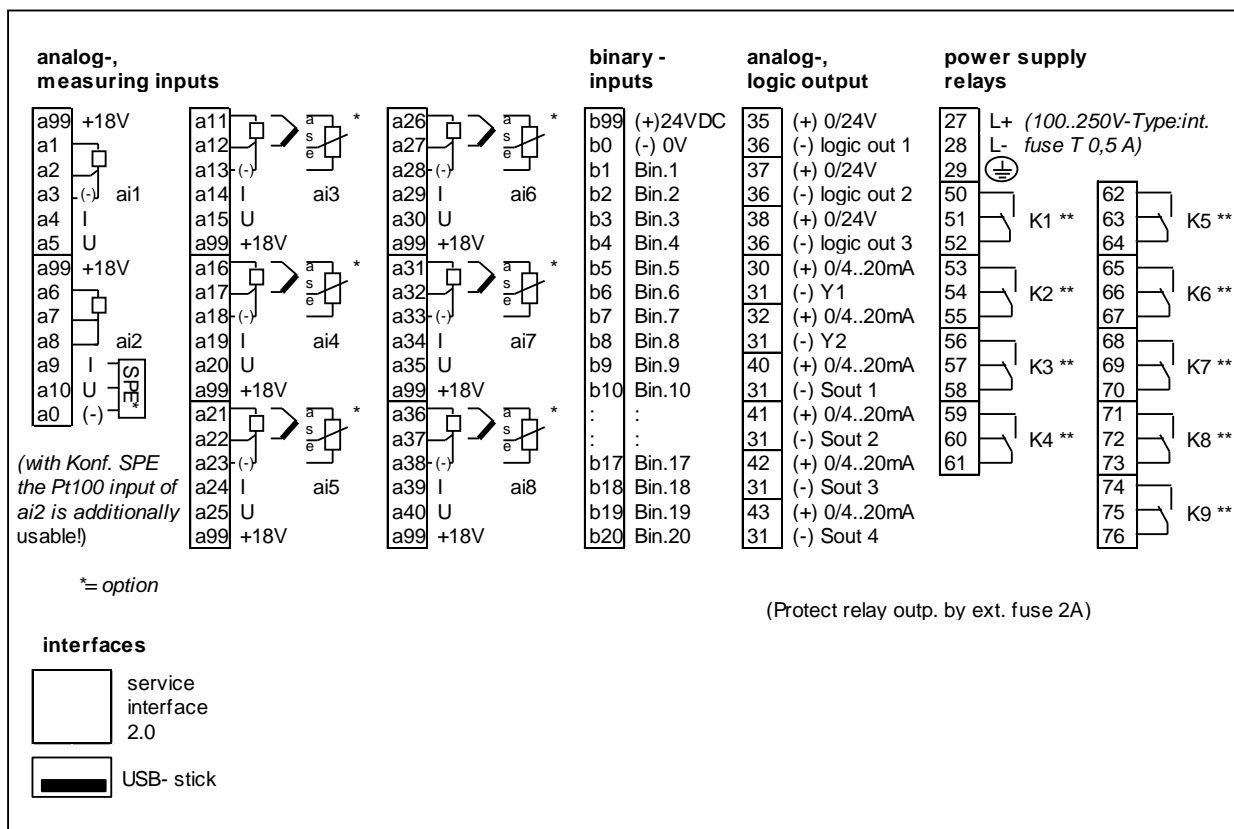

Wiring, examples for input 1 and output 1 respectively:

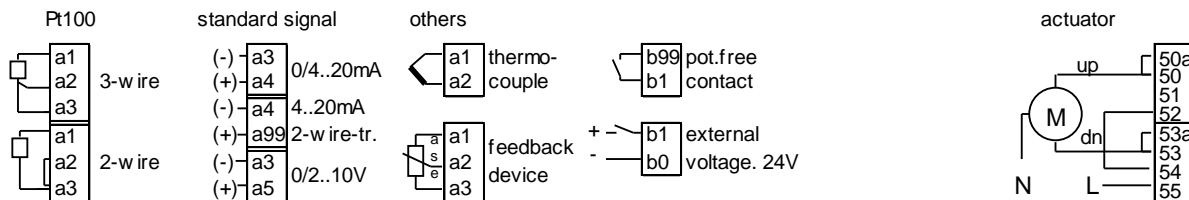

**** RC- element:**

The RC- element is a component to protect the relay contact in case of higher loads. The RC- elements must not be used with small loads, for example auxiliary relays (depending on capacity) or electronic burner managers (note the manufacturer's instructions).

Depending on version, RC elements for external mounting are enclosed or internal RC elements are wired on terminals for the selective connection (factory set: N.O. contact with RC element).





KFM-Regelungstechnik GmbH
Planckstraße 2
32052 Herford, Germany

Internet: www.kfm-regelungstechnik.de
E-Mail: info@KFM-Regelungstechnik.de

Telefon: +49 (0) 52 21 / 77 08 - 0
Telefax: +49 (0) 52 21 / 77 08 - 43

© "reproduction by permission only"